



Disclaimer, warranties and limitation of liability

This publication is intended to be an aid for all trades and professionals involved with specifying and installing LYSAGHT products and not to be a substitute for professional judgement.

Terms and conditions of sale available at local BlueScope Lysaght sales offices.

Except to the extent to which liability may not lawfully be excluded or limited, BlueScope Steel Limited will not be under or incur any liability to you for any direct or indirect loss or damage (including, without limitation, consequential loss or damage such as loss of profit or anticipated profit, loss of use, damage to goodwill and loss due to delay) however caused (including, without limitation, breach of contract, negligence and/or breach of statute), which you may suffer or incur in connection with this publication.

© Copyright BlueScope Steel Limited May 14, 2008

Accessory sheet

NSW	Victoria	Qld	SA & NT	WA	Tasmania
BMT 0.55	BMT 0.55 ZL, GB, CB	BMT 0.40 & 0.55	BMT 0.55	BMT 0.40-&-0.55	BMT 0.55 • ZL
Materials • ZL • Single-sided CB with strippable coating	Dimensions 1800 x 900 1800 x 1200 2400 x 900 2400 x 1200	Materials ZL, CB, GB & stainless	Materials ZL & CB	Materials • ZL • GB • Single-sided CB	• Single-sided CB with strippable coating • AQUAPLATE CB
Dimensions 2400 x 1200		Dimensions 2400 x 1200	Dimensions To order	Dimensions 2400 x 1200	Dimensions 2400 x 1200

Flat strips (hoop iron)

Available in Queensland & WA

Materials	Dimensions & lengths			
Qld: ZL or GB WA: GB	0.4 x 25 & 0.4 x 38 1800 & 2400	0.6 x 25 & 0.6 x 38 1800 & 2400	0.8 x 25 2400	1.0 x 25 2400

Strapping (coils)

NSW	Victoria	Qld	SA	NT	Tasmania
25 x 1.0	32 x 1.2 x 100 m	30 x 1.0 x 30 m	25 x 0.6	25.4 x 0.6	25 x 1.0
25 x 1.2					25 x 1.2
25 x 1.6	38 x 1.2 x 100 m 38 x 1.6 x 100 m	32 x 1.2 x 50 m 32 x 1.2 x 25 m	51 x 1.6	51 x 1.6	25 x 1.6
32 x 1.0					32 x 1.2
32 x 1.2		51 x 1.6 x 25 m			32 x 1.6
32 x 1.6					
38 x 1.2					38 x 1.2
38 x 1.6					38 x 1.6
51 x 1.6					51 x 1.6

Abbreviations

CB	= COLORBOND® colours on ZINCALUME® steel
CU	= Copper unpainted
GB	= GALVABOND® steel unpainted
SS	= Stainless steel unpainted
ZL	= ZINCALUME® steel unpainted
All measurements are millimetres	

Silicone sealant

Colours

Clear, grey & other colours.
Clear & grey only in NSW, SA & Qld.
Only clear in Vic.

Sizes

Single tubes or cartons of 20 tubes

Soft zinc flashing

This material is ZL & CB compatible

Thickness

0.7 mm

Length

6 metre rolls

Widths

110, 150, 230, 300, 380, 460, 580 mm

Tools (turn-up/turn-down) & notching tools

Not all tools are available in all areas. Refer to your local service office for availability.

CUSTOM ORB

Speednotcher

INTEGRITY 820

Qld & NSW only
Turn up/down
Speednotcher

KLIP-LOK 700 HS

Turn up/down
Speednotcher

SPANDEK

Turn up
Speednotcher

LONGLINE 305

Turn up/down
Speednotcher
Button punch
Rib closing tool
End-lap tool

TRIMDEK

Turn up/down
Speednotcher

KLIP-LOK 406

Turn up/down
Speednotcher
NSW only

Tools (for building frames)

- Stud hand shear
- Hand hole punch
- Uni-hand shear blade
- Uni-hand side blade

Not all tools are available in all areas. Refer to your local service office for availability.

Abbreviations

CB = COLORBOND® colours on ZINCALUME® steel
CU = Copper unpainted
GB = GALVABOND® steel unpainted
SS = Stainless steel unpainted
ZL = ZINCALUME® steel unpainted
All measurements are millimetres

Ventilated ridges

All ventilator ridges are custom made to order

NSW	Vic	Qld	SA & NT	WA	Tasmania
Refer to the Service Offer for details.	Materials ZL, CB, GB, Cu, SS	Materials ZL, CB	Materials ZL, CB	Materials ZL, CB, ULTRA & SS	Materials ZL, CB
	Throat sizes 150 225 300	Throat sizes MX series: custom made up to 900 mm	Throat sizes 125 150 200 250 300 350 450 480 600	Throat sizes 150, 200, 300, 400 & 600	Throat sizes 125 150 225 300
	Stop ends Supplied loose.	TC series: custom made up to 600 mm		Standard	
	Closed top	MX series		Ranceline	Stop ends Supplied loose or fitted.
	Open top	TC series	Stop ends Supplied loose or fitted.	Also available as Slope vents for fitting to face of roof.	
		Stop ends Supplied loose.		Options • Dampers • Heavy duty brackets • Stop ends • Bird-proofing	

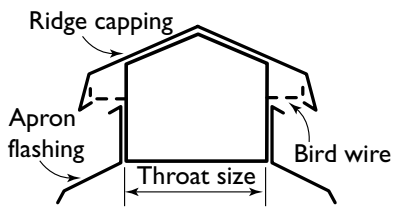

Standard

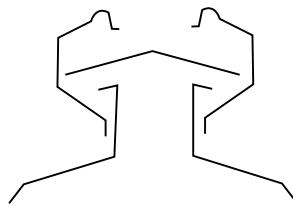

Ranceline

WA ventilator ridges

Slope vents are supplied assembled; others are usually knocked-down.

For quote or order state:

1. Type
2. Throat size
3. Material
4. Roof pitch
5. Roof profile
6. Number of stop ends
7. Bird-proofing
8. Dampers

Louvres

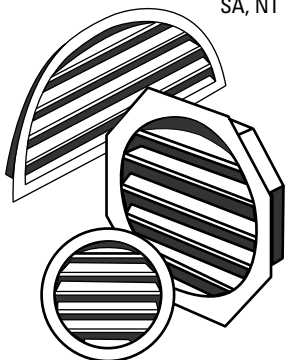

Available
SA, NT & WA

Material
0.6 mm GB

Finish
Powdercoating
CB.

In WA: ZL, CB, ULTRA, SS
Ask about non-standard sizes and shapes (including triangular)

Sizes Round
340 mm dia
620 mm dia
Ask for non-standard sizes

Sizes Half-round
900 x 500
Ask for non-standard sizes

Sizes Octagonal
620 mm dia
Ask for non-standard sizes
Square & Rectangular
Also available in SA
Ask for non-standard sizes

Shower liners

Available in NSW

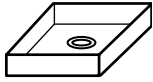

BMT 0.55	Dimensions All 150 deep 900 x 900 1000 x 900 1100 x 900 1200 x 900 1000 x 1000	1100 x 1000 1200 x 1000 1200 x 1100 1200 x 1200 1300 x 1100
Materials Copper or Stainless steel		Larger sizes available.

Box gutter brackets

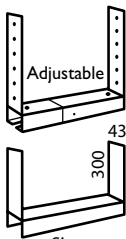

Sizes:
350/400
400/650
650/1000

Vic & NSW	Qld	SA (called straps & saddles)	WA Called Adjustable straps & saddles
Construction Adjustable	Construction Spot welded & adjustable		
Materials ZL	Materials ZL	Materials ZL	Materials ZL
Width Size 1: 250–400 Size 2: 400–650 Size 3: 650–1000	Width Up to and including: Size 1: 250–400 Size 2: 400–650 Size 3: 650–1000	Width Size 1: 250–400 Size 2: 400–650 Size 3: 700–1000	Width Small: 250–400 Medium: 400–650 Large: +650–1000

Box gutter sumps

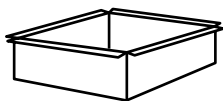
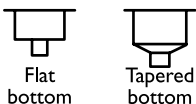

Vic & NSW	Qld	SA	WA
Materials ZL & CB	Materials GB, ZL & CB	Materials ZL, CB & GB	Materials ZL & CB
Size Custom made to order	Sizes Custom made to order All 150 deep 200 x 200 300 x 300 400 x 400 450 x 450 500 x 500 550 x 550 600 x 600	Sizes Any size to order	Sizes 250 x 250 x 100 300 x 225 x 225 300 x 300 x 250 375 x 225 x 225 375 x 225 x 225 450 x 300 x 300 600 x 600 x 100 Ask about non- standard

Box gutter expansion joints

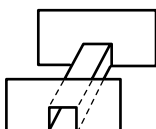

Qld, WA &
NSW

Materials
ZL & CB

Lengths
Up to 400
Over 400

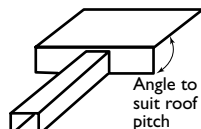

Abbreviations	
CB	= COLORBOND® colours on ZINCALUME® steel
CU	= Copper unpainted
GB	= GALVABOND® steel unpainted
SS	= Stainless steel unpainted
ZL	= ZINCALUME® steel unpainted
All measurements are millimetres	

Rainwater heads

NSW

Refer to the Service Offer for details.

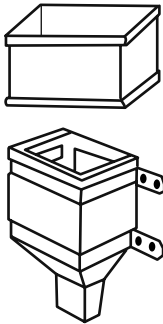

Vic

Materials
ZL & CB

Sizes
Custom made to order

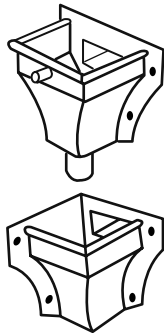

Qld

Materials
GB, ZL & CB

Sizes
Custom made to order

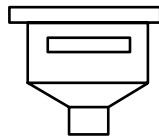

Round rainwater heads custom made to order

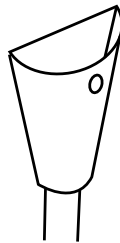

Contact SA branch for details on the full rainwater head range.

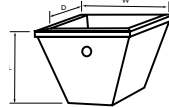

Ornamental Rainhead

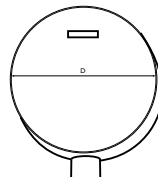

Full Moon Rainhead

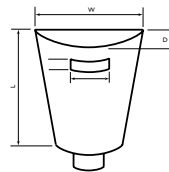

Bushranger Rainhead

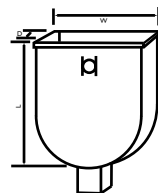

Tulip Rainhead

SA & NT

Materials
ZL & CB

Sizes

Standard
225 x 300 x 250 deep
225 x 375 x 250 deep

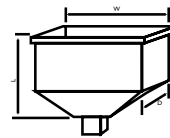

Colonial
170 x 260 x 340 deep
195 x 290 x 340 deep

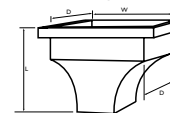

Antique Rainhead

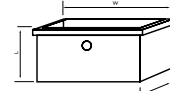

Standard Rainhead

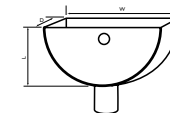

Half Moon Rainhead

WA

Materials
ZL, GB & CB

Sizes

Flat bottom
300 x 750 x 150
375 x 225 x 225
600 x 300 x 300

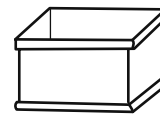

Tapered bottom

250 x 200
300 x 200
400 x 250
450 x 300
600 x 450

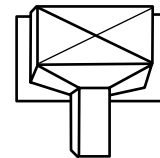

In WA & NSW, trade work can manufacture to client's details.

Plasterer's angle

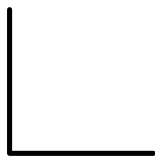

Queensland

Lengths

Sizes

1800
2400

25 x 25
38 x 38
50 x 50
75 x 75

Materials
0.4 BMT ZL

Chamfer board flashing (n/a in Qld)

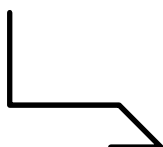

Queensland

Lengths

Sizes

1800

25 x 38

Materials
0.4 BMT ZL

Transitions, roof collars & overflows

Queensland

NSW

Materials
ZL & CB

Refer to the Service Offer for details.

Sizes
Custom made to order

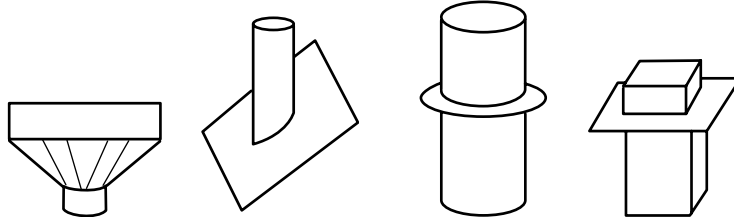

Fixed metal louvres

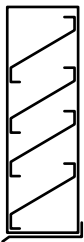

**Queensland
NSW and W.A.**

Materials
ZL, GB & CB

Sizes
Qld: 1200 (H) x
900 (W) x 75 (D)

NSW & WA:
Custom made to order.

Translucent sheeting (Contact local branch for availability)

CUSTOM ORB
(Polycarbonate & fibreglass)



FLATDEK
(Fibreglass)



INTEGRITY 820
(Fibreglass)



KLIP-LOK 406
(Fibreglass)

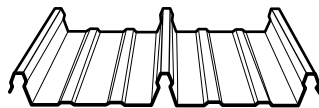

KLIP-LOK 700
(Fibreglass)

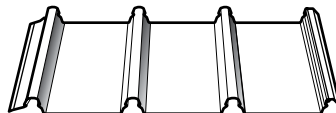

LONGLINE 305
(Fibreglass)

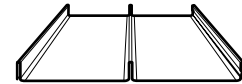

SPANDEK
(Fibreglass)



TRIMDEK
(Polycarbonate & fibreglass)



GRECA
(Polycarbonate & fibreglass)



KLIP-LOK MAXIMA
(Fibreglass)

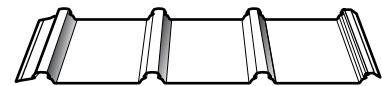

(WA only, 770 mm wide)

Materials

Fibreglass
2400 g/m²
(1800 g/m² & 3050 g/m² subject to enquiry)

Colours

Polycarbonate
Clear, Opal, bronze & grey

Fibreglass

CUSTOM ORB & TRIMDEK:
clear, opal & light green.
All other profiles: clear & opal.
(Other colours subject to enquiry.)

Lengths

Polycarbonate
1800, 2400, 3000, 3600, 4200, 5400, 6000

Fibreglass

1800 to 12200
(Other lengths subject to enquiry.)

Fastening

All screws should have 32 mm
Weatherlok® washers.

Weatherlok® is a registered trademark of ITW Buildex.

Abbreviations

CB = COLORBOND® colours on ZINCALUME® steel
CU = Copper unpainted
GB = GALVABOND® steel unpainted
SS = Stainless steel unpainted
ZL = ZINCALUME® steel unpainted
All measurements are millimetres

Ant caps

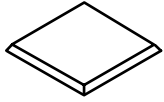

Queensland & WA

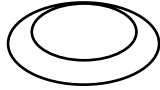

Queensland only

Queensland

Materials

ZL & CB

Sizes square

200 x 200
225 x 225
250 x 250
300 x 300

Sizes round

200 diameter
250 diameter
300 diameter

WA

Materials

ZL & CB

Sizes

Square only
100 x 100
225 x 225

Dektite® pipe flashings

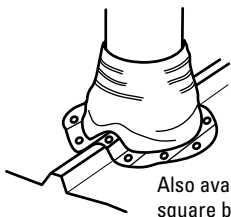

Also available in square base.

Available in silicone (green, red, beige, off-white) and EPDM (black and grey) (Red, black or grey in WA)

Not available in Victoria. Refer to NSW service offer for further details. Dektite® is a registered trademark of Dek Industries Pty Ltd.

Sizes (pipe diameter)

0—35
5—55
50—70
70—110
110—160
160—220
220—300
290—380

Dektite Square Base available in SA.

Sizes (pipe diameter)

0—35
5—55
50—70
5—120
110—170
160—220
160—300
290—440

Weatherlok washers

For use under the head of fasteners fixing translucent sheeting. (Allow 10 mm extra length for screws.)



Diameter

20
32

Lapseal

Lapseal is a tape placed under translucent sheeting, on top of purlins, to prevent cracking noises from expansion.



Width

50
75
100

Thickness

6 mm

Length

11.7 metres

Roof infill strips (closed cell type)

Except for CUSTOM ORB, specify top or bottom.

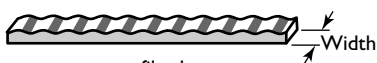

CUSTOM ORB profile shown

Length

CUSTOM ORB	915
TRIMDEK	970
SPANDEK	745
KLIP-LOK 406	812
KLIP-LOK 700HS	710
KLIP-LOK MAXIMA	770
INTEGRITY 820	890
FLATDEK	roll
FLATDEK II	roll

Width

All profiles
20

We also have infills for FLATDEK and FLATDEK II, but these are not in strips.

Safety mesh

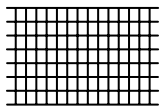

Mesh	Mesh	Mesh	Mesh
100 x 115 x 1.25	150 x 150 x 1.6	150 x 300 x 2	150 x 300 x 3.15
Roll width 1800	Roll width 1800	Roll width 1800	Roll width 900
Roll length 50 metres	Roll length 50 metres	Roll length 50 metres	Roll length 60 metres
Roll area 90 m ² Called Insulmesh in SA	Roll area 90 m ² N/A in SA.	Roll area 90 m ² Called Roofsafe in SA, Safety mesh in Qld & W.A.	Roll area 54 m ² N/A in SA.

Minimum lengths apply for custom cut. Refer to NSW service offer.

Chicken wire

Not available in Qld, Vic. or WA.

Mesh	Roll width	Roll area
50 mm dia.	1800	90 m ²

Refer to NSW service offer.

Ventilators: Industrial

Not available in W.A.

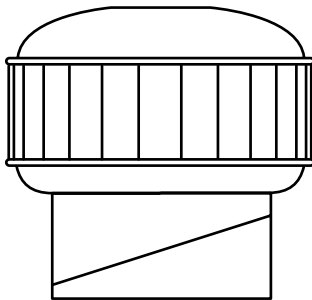

Wind-driven Hurricane with Vari-pitch throat (Alternative brand in SA)	Throat diameters	Model	Capacity (l/sec) at 12 km/h
Material Aluminium	Model number indicates diameter in mm	H100	33
		H150	210
Finish Most COLORBOND® colours	Options Include electrically-controlled dampers	H225	370
		H300	480
		H400	630
		H450	790
		H500	900
		H600	1104
		H700	1630
		H800	2131
H900	2700		

Refer to NSW service offer.

Ventilators: Domestic

Not available in Victoria. Various brands available in Queensland or W.A.

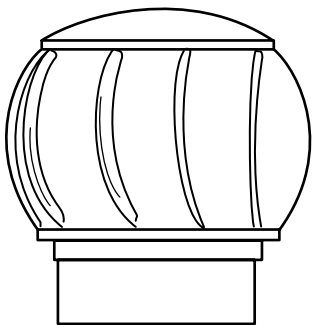

Wind-driven Windmaster 300 with Vari-pitch throat (Alternative brand in SA)	Throat diameter	Model	Capacity (l/sec) at 12 km/h
Material Aluminium	300 mm	W300	348
		Options Include Whirlymate adjustable ceiling register 300 x 300 white plastic	

Refer to NSW service offer.

Skylight tubes

Not available in Victoria, SA, WA or Queensland. Refer to NSW local service centres.

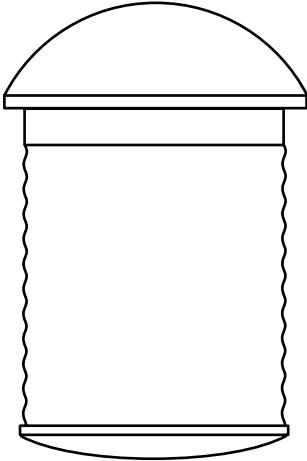

SolarBrite 300

Throat diameter
300

Includes
2000 mm length of reflective tubing, ceiling register & aluminium flashing

Colours
Unfinished aluminium

SolarBrite Plus

Includes controllable ventilation

Throat diameters
350
400
500

Includes
2000 mm length of reflective tubing, ceiling register & aluminium flashing

Colours
Most COLORBOND® colours

Skylights

Not available in Victoria, SA or WA. Refer to NSW local service centres.

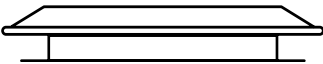

Venting or non-venting designs available

Models
• Corrolux (flashing matches CUSTOM ORB)

• Universal metal deck (flashing matches rib heights up to 50 mm)

Corrolux sizes

500 x 500
500 x 800
500 x 1200

600 x 600
600 x 800
600 x 1200

800 x 800
800 x 1200

Universal sizes

500 x 500
500 x 800
500 x 1200

600 x 600
600 x 1200

800 x 800

Fasteners: Screw to steel—AS3566 Class 3 and Class 4

Refer to New South Wales for details of available fasteners. Class 3 fasteners not available in Queensland. All other states, refer to local office.

All fasteners, except those zinc plated, are available powder-coated to match COLORBOND® colours.

Coating Class 3

Gauge	TPI	Length
-------	-----	--------

Self drilling tapping screw for thin gauge steel (with underwasher thread) with seal



13	13	41
13	13	55
15	15	55

Self drilling tapping screw for steel (with underwasher thread) with seal



12	14	35
12	14	45
12	14	55
12	14	68

Hex. head Self drilling tapping screw for steel with seal (full thread)



8	18	12
10	16	16
10	24	16
10	16	25
12	14	20
14	10	25
14	10	45

Hex. head Self drilling tapping screw (full thread) no seal



10	16	16
10	16	25
12	14	20
12	14	30
12	14	45
14	20	22

Hex. head Self drilling self tapping screw with seal (part thread)



14	10	42
14	10	50
14	10	65

Stitching screws

Hex. head with seal



10	12	20
----	----	----

Hex. head with 19 mm aluminium bonded washer



14	10	42
14	10	50
14	10	65

Refer to AS3566 Class 3 and Class 4. Fasteners used should be Lysaght approved.

Coating Class 4

Gauge	TPI	Length
-------	-----	--------

Roofzips® Hex. head Self drilling tapping screw for steel (with underwasher thread) with seal

12(M6)	11	50mm
--------	----	------

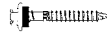

Hex. head Self drilling tapping screw for steel (with underwasher thread) with seal



12	14	35
12	14	45
12	14	68

Hex. head Self drilling self tapping screw for steel (with underwasher thread) with seal (full thread)

10	16	16
12	14	20
14	10	42



Hex. head, no seal

10	16	16
10	16	25
12	14	55
12	14	65
12	14	75
14	20	22
14	10	25
14	10	42
14	10	50



Hex. head with 19 mm aluminium bonded washer



14	10	42
14	10	50
14	10	65

Self drilling self tapping screw with 19 mm aluminium bonded washer



15	15	47
----	----	----

Fasteners we recommend for our products are specified in our product publications.

Zinc plated

Gauge	TPI	Length
-------	-----	--------

Wafer head

10	16	16
10	16	22



Hex. head, no seal

8	18	12
10	16	16

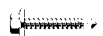

Coating Class 3 coated

Gauge	TPI	Length
-------	-----	--------

Wafer head

10	16	16
10	16	22



Ripple Tek®

10	16	20
10	16	30



Ripple Tek® and Roofzips® are registered trademarks of ITW Buildex.

Fasteners: Screw to timber

Refer to New South Wales for details of available fasteners. Class 3 fasteners not available in Queensland. All other states, refer to local office.

All fasteners, except those zinc plated, are available powder-coated to match COLORBOND® colours.

Coating class 3 coated

Gauge TPI Length

Hex. head with thread under washer with seal



12	11	50
12	11	65

Hex. head with seal (full thread)



10	12	25
12	11	25
14	10	25

Hex. head with seal (part thread)



12	11	45
14	10	50
14	10	65

Hex. head no seal (full thread)



10	12	25
12	10	25
14	10	25

Hex. head, no seal (part thread)



12	11	45
12	11	50
14	10	50
14	10	65

Ripple Tek® screws (30 mm) are used for fixing MINI ORB to timber — see previous page for sizes.

Coating class 3 coatings are to AS 3566 class 3. Coating class 4 coatings are to AS 3566 class 4.

Coating class 4 coated

Gauge TPI Length

Roofzips® Hex. head Self drilling screw for steel or timber (with underwasher thread) with seal

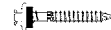

12(M6)	11	50mm
--------	----	------

Hex. head with thread under washer with seal



12	11	65
----	----	----

Hex. head with seal

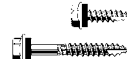

12	11	25
14	10	25
14	10	50
14	10	65
14	10	75
14	10	90

Hex. head, no seal (N/A in Queensland)

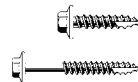

12	11	25
14	10	25
14	10	50
14	10	65

Hex. head with 16 mm aluminium bonded washer



14	10	50
14	10	65

Hex. head with 19 mm aluminium bonded washer



14	10	50
14	10	65

Hex. head with 25 mm aluminium bonded washer



14	10	50
14	10	65

Fasteners we recommend for our products are specified in our product publications.

Zinc plated

Gauge TPI Length

Wafer head



10	12	25
10	12	45

Countersunk head (N/A in Queensland)

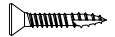

6	18	25
---	----	----

Bugle head batten

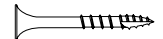

14	10	75
14	10	100

Fastener drive tools

Across flats Length

Hexagon sockets



5/16 inch	45
5/16 inch	65
3/8 inch	65

Across flats Length

Phillips drive bits



#2	50
----	----

Length

Magnetic bit holder



75

Fasteners: Cyclonic assemblies–Screw to steel

Available in WA, NT and Qld. Class 3 fasteners not available in Queensland.

Coating class 3 coated

Gauge	TPI	Length
-------	-----	--------

For Custom Orb

14	10	42
----	----	----

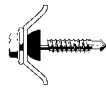

For Spandek & Trimdek

14	10	50
----	----	----

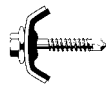

For Klip-Lok

14	10	65
----	----	----

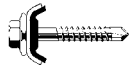

Coating class 4 coated

Gauge	TPI	Length
-------	-----	--------

Metal Batten Tekes
for Custom Orb

15	15	47
----	----	----

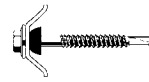

Metal Batten Tekes
for Spandek & Trimdek

14	10	50
----	----	----

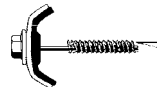

Metal Batten Tekes
for Klip-Lok

14	10	65
----	----	----

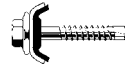

Fasteners: Cyclonic assemblies–Screw to timber

Not available in NSW. Available in WA, NT and Qld.

Coating class 4 coated

Gauge	TPI	Length
-------	-----	--------

Hex. head
for Custom Orb

14	10	50
14	10	65

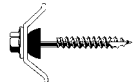

Hex. head for
Spandek & Trimdek

14	10	65
14	10	75

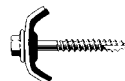

Hex. head
for Klip-Lok

14	10	75
----	----	----

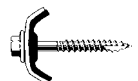

Fasteners: Nails to timber

Refer to New South Wales Service Offer for details of available fasteners.

Galvanised spiral-threaded steel nail



3.75 diameter x 40 long
3.75 diameter x 60 long

Fasteners: Blind rivets

Fasteners in New South Wales and South Australia are sold in packs of 100.

Not available in Victoria.

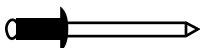

Body	Mandrel	Dia.	Grip	Type	Head
Aluminium	Steel	3.2	8	Plain	Button

Insulation: Reflective foil laminate

Refer to New South Wales or Queensland Service Offer for details. All other states, refer to local sales office.

Lightweight

Plain facing

1350 x 20 m (27 m²)
1350 x 60 m (81 m²)

Anti-glare facing

1350 x 20 m (27 m²)
1350 x 30 m (40.5 m²)
1350 x 60 m (81 m²)

Building grade—Anti-glare

1350 x 20 m (27 m²)
1350 x 60 m (81 m²)

Mediumweight

Plain facing

1350 x 20 m (27 m²)
1200 x 60 m (72 m²)
1350 x 60 m (81 m²)

Anti-glare facing

1350 x 20 m (27 m²)
1350 x 30 m (40.5 m²)
1350 x 60 m (81 m²)

Perforated

1350 x 60 m (81 m²)

Sisaltuff

1350 x 60 m (81 m²)

Heavyweight

Plain facing

1350 x 20 m (27 m²)
1200 x 60 m (72 m²)
1350 x 60 m (81 m²)

Anti-glare facing

1350 x 20 m (27 m²)
1350 x 30 m (40.5 m²)
1350 x 60 m (81 m²)

Perforated

1350 x 60 m (81 m²)

Gladiator wallwrap

1350 x 60 m (81 m²)

Thermotuff wallwrap

1350 x 60 m (81 m²)

Insulation: Building blanket with foil

Lightweight foil facing

R1.5 1200 x 15 m (18 m²)
R1.5 1200 x 20 m (24 m²)

R2.0 1200 x 10 m (12 m²)
R2.0 1200 x 15 m (18 m²)

R2.5 1200 x 10 m (12 m²)

Mediumweight foil facing

R1.5 1200 x 15 m (18 m²)
R1.5 1200 x 20 m (24 m²)

R2.0 1200 x 10 m (12 m²)
R2.0 1200 x 15 m (18 m²)

R2.5 1200 x 10 m (12 m²)

Heavyweight foil facing

R1.5 1200 x 15 m (18 m²)
R1.5 1200 x 20 m (24 m²)

R2.0 1200 x 10 m (12 m²)
R2.0 1200 x 15 m (18 m²)

R2.5 1200 x 10 m (12 m²)
R2.5 1200 x 7.5 m (9 m²)

Insulation: Building blanket

Lightweight

R1.2 1200 x 15 m (18 m²)
R1.2 1200 x 20 m (24 m²)
R1.2 1200 x 30 m (36 m²)

R1.8 1200 x 10 m (12 m²)
R1.8 1200 x 15 m (18 m²)
R1.8 1200 x 20 m (24 m²)

R2.3 1200 x 10 m (12 m²)
75 mm 1200 x 20 m (24 m²)

Mediumweight

R1.5 1200 x 15 m (18 m²)
R1.5 1200 x 20 m (24 m²)

R2.0 1200 x 10 m (12 m²)
R2.0 1200 x 15 m (18 m²)

R2.5 1200 x 10 m (12 m²)

Heavyweight

R1.5 1200 x 15 m (18 m²)
R1.5 1200 x 20 m (24 m²)

R2.0 1200 x 10 m (12 m²)
R2.0 1200 x 15 m (18 m²)

R2.5 1200 x 10 m (12 m²)
R2.5 1200 x 7.5 m (9 m²)

Insulation: Ceiling batts

R2.0 1160 x 430 16 per pack (8 m²)
R2.0 1160 x 580 16 per pack (10.8 m²)

R2.5 1160 x 430 16 per pack (8 m²)
R2.5 1160 x 580 16 per pack (10.8 m²)

R3.0 1160 x 580 16 per pack (10.8 m²)

Insulation: Wall batts

R2.0 1160 x 430 16 per pack (8 m²)
R2.0 1160 x 580 16 per pack (10.8 m²)
R1.5 1170 x 430 30 per pack (15 m²)
R1.5 1170 x 580 26 per pack (17.5 m²)
R2.0 1160 x 580 8 per pack (5 m²)

Insulation: Tape

Reinforced foil, 48 mm wide