

Klip-lok 700 Hi-Strength®

Concealed-fixed
steel cladding



- Wide cover concealed-fixed cladding with no exposed fasteners for weathertight roofs
- Optional on-site long length mobile rollforming available.
- Bold rib makes strong visual statement
- Easy-to-install fixing clip means roof can be laid faster and more economically
- New clip design enhances performance



Lysaght Klip-lok 700 Hi-Strength®

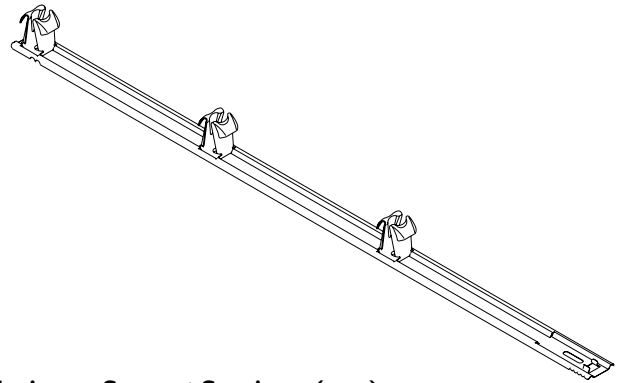
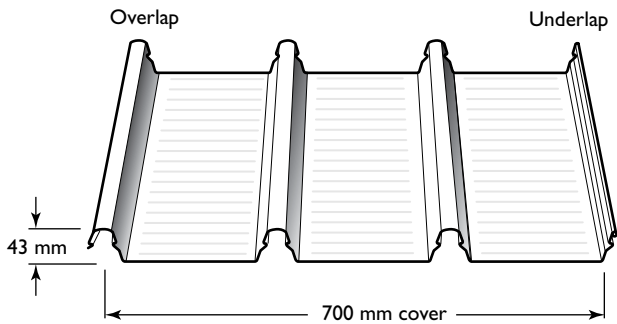

LYSAGHT KLIP-LOK 700 HI-STRENGTH® (KL-700HS) is truly a superior product. Visually, a bold rib makes a strong statement rising from the flat pans. Thermal expansion of long, straight runs are achievable, and with no exposed fasteners, the long, straight lines of KL-700HS remain clean and smooth.

At the heart of our system is our fixing clip, which can be laid in place and fixed simpler and faster than ever before. This is because the KL-700HS clip is fixed with hex. head screws, which are easier to drive. The clip also gives roofers the ability to accommodate up to 100mm of insulation.

KL-700HS is now available in rolled on-site lengths and an extra thickness.

Our mobile on-site rollformer means extra long lengths of KL-700HS can be made on-site, which looks fantastic and eliminates expansion joints.

Longitudinal fluting is also available from the mobile rollformer for long length spring-curved applications.

Colours

KL-700HS is available in an attractive range of COLORBOND® steel colours, plain ZINCALUME® (aluminium/zinc alloy coated steel). Stainless steel is also available subject to enquiry.

COLORBOND® Metallic steel provides superior aesthetic qualities, and COLORBOND® Ultra steel is intended for severe coastal or industrial environments. (Both available subject to enquiry.)

Masses Klip-lok 700 Hi-Strength

BMT		kg/m	kg/m ²	m ² /t
0.42	ZINCALUME®	3.26	4.66	215
0.42	COLORBOND®	3.32	4.74	211
0.48	ZINCALUME®	3.70	5.29	189
0.48	COLORBOND®	3.76	5.37	186
0.60*	ZINCALUME®	4.59	6.55	153
0.60*	COLORBOND®	4.64	6.63	151

*0.60 BMT Available from mobile rollformer only.

Material specifications

KLIP-LOK 700 HI-STRENGTH is made from:

- ZINCALUME® aluminium/zinc alloy-coated steel complying with AS 1397—2001 G550, AZ150 (550 MPa minimum yield stress, 150 g/m² minimum coating mass); or
- Stainless steel standard grade designation is AISI/ASTM Type 430; UNS No. S43000 (on request only)

The base metal thicknesses are 0.42, 0.48 (and 0.60mm mobile rollformer only).

The COLORBOND® prepainted steel complies with AS/NZS 2728:2007.

Lengths

Mobile rollformed sheets are custom cut on-site. Factory sheets cut to order.

Maximum Support Spacings* (mm)

Type of span	BMT (mm)		
	0.42	0.48	0.60 [†]
Roofs			
Single span	1650	2050	2350
End span	1750	2350	3000
Internal span	2200	2800	3600
Unstiffened eaves overhang	150	200	250
stiffened eaves overhang	450	500	550
Walls			
Single span	2600	3000	3300
End span	3200	3450	3600
Internal span	3850	3900	3900
Overhang	150	200	250

*For roofs: the data are based on foot-traffic loading

*For walls: the data are based on pressures for transverse fluted material

*Above table is based on supports of 1mm BMT.

[†]0.60..BMT available from mobile rollformer only.

The maximum recommended support spacings are based on testing in accordance with AS1562.1-1992, AS4040.0-1992 and AS4040.1-1992.

Roof spans consider both resistance to wind pressure and light roof traffic (traffic arising from incidental maintenance).

Wall spans consider resistance to wind pressure only.

The pressure considered is based on buildings up to 10m high in Region B, Terrain Category 3, M_s=0.85, M_i=1.0,

Tolerances

Length: +0mm, -15mm; Width: +4mm, -4mm

Make allowance for thermal expansion or contraction for long length roofs at sheeting ends.

The equation $\Delta L = \alpha \times \Delta T \times L$ gives an indication of the sheeting extent or contraction (ΔL).

$\alpha = 12 \times 10^{-6}$ (coefficient of linear expansion for steel)

ΔT = temperature change in °C

L = sheet length in mm

M_i=1.0 with the following assumptions made:

Roofs:

C_{pi}=+0.20, C_{pe}=-0.90, K_i=2.0 for single and end spans, K_i=1.5 for internal spans.

Walls:

C_{pi}=+0.20, C_{pe}=-0.65, K_i=2.0 for single and end spans, K_i=1.5 for internal spans. These spacings may vary by serviceability and strength limit states for particular projects.

Klip-Lok 700 Hi-Strength (Transverse Flutes) : Limit state wind pressure capacities (kPa)

Span Type	Limit State	Span (mm)									
		900	1200	1500	1800	2100	2400	2700	3000	3300	3600
base material thickness-0.42mm											
Single	Serviceability	3.08	2.53	2.00	1.53	1.15	0.86	0.65	0.49	0.37	
	Strength *	4.95	4.15	3.50	2.85	2.30	1.85	1.55	1.30	1.05	
End	Serviceability	3.05	2.73	2.40	2.02	1.64	1.32	1.07	0.91	0.79	0.70
	Strength *	5.55	4.30	3.35	2.75	2.55	2.40	2.20	1.85	1.50	1.15
Internal	Serviceability	2.90	2.64	2.39	2.16	1.94	1.74	1.55	1.38	1.20	1.03
	Strength *	5.40	4.60	3.90	3.25	2.75	2.40	2.20	2.00	1.75	1.50
base material thickness-0.48mm											
Single	Serviceability	4.22	335	254	183	128	090	069	057	051	
	Strength *	6.30	520	425	335	270	215	180	160	145	
End	Serviceability	3.81	334	288	243	202	167	138	1.15	0.97	0.80
	Strength *	6.30	510	415	355	315	285	250	2.20	1.80	1.40
Internal	Serviceability	3.76	332	291	254	224	201	1.84	1.68	1.48	1.27
	Strength *	6.35	555	480	410	360	320	285	2.60	2.25	1.85

0.60 BMT option is available exclusively from mobile rollformer. These values are given in blue.

base material thickness-0.60mm											
Single	Serviceability	6.65	5.41	4.23	3.18	2.33	1.70	1.27	0.97	0.74	
	Strength *	8.30	7.10	5.95	4.95	4.05	3.35	2.85	2.40	2.05	
End	Serviceability	6.38	5.33	4.36	3.51	2.82	2.28	1.88	1.59	1.38	1.21
	Strength *	8.20	6.70	5.45	4.60	4.00	3.60	3.20	2.75	2.35	1.90
Internal	Serviceability	5.65	5.17	4.70	4.24	3.78	3.32	2.88	2.44		
	Strength *	7.25	6.45	5.75	5.10	4.55	4.10	3.75	3.45		

* A capacity reduction factor of $\phi=0.90$ has been applied to strength capacities. Above table is based on support of 1mm BMT.

Longitudinal fluting option is available exclusively from mobile rollformer. These values are given in blue.

Klip-Lok 700 Hi-Strength (Longitudinal Flutes) : Limit state wind pressure capacities (kPa)

Span Type	Limit State	Span (mm)									
		900	1200	1500	1800	2100	2400	2700	3000	3300	3600
base material thickness-0.42mm											
Single	Serviceability	2.52	2.05	1.60	1.22	0.91	0.69	0.56	0.48	0.43	
	Strength *	4.85	4.10	3.40	2.75	2.20	1.80	1.45	1.20	1.05	
End	Serviceability	2.65	2.48	2.26	1.92	1.53	1.19	0.94	0.79	0.70	0.65
	Strength *	3.40	2.95	2.60	2.30	2.15	2.00	1.80	1.55	1.30	1.00
Internal	Serviceability	2.63	2.40	2.17	1.96	1.76	1.57	1.41	1.25		
	Strength *	3.85	3.40	3.00	2.65	2.35	2.15	2.00	1.95		
base material thickness-0.48mm											
Single	Serviceability	2.80	2.27	1.77	1.33	0.98	0.74	0.59	0.50	0.44	
	Strength *	5.80	4.75	3.80	2.95	2.30	1.80	1.50	1.30	1.15	
End	Serviceability	3.11	2.51	2.01	1.64	1.40	1.23	1.07	0.93	0.80	0.67
	Strength *	5.10	4.05	3.20	2.65	2.30	2.10	1.85	1.60	1.30	1.00
Internal	Serviceability	2.68	2.47	2.27	2.09	1.94	1.81	1.70	1.60		
	Strength *	5.00	4.30	3.65	3.10	2.70	2.45	2.35	2.30		
base material thickness-0.60mm											
Single	Serviceability	5.12	4.24	3.41	2.66	2.04	1.56	1.20	0.92	0.69	
	Strength *	7.20	6.30	5.45	4.60	3.90	3.30	2.80	2.35	1.95	
End	Serviceability	5.40	4.31	3.40	2.76	2.34	2.05	1.79	1.54	1.31	1.09
	Strength *	7.10	6.05	5.05	4.25	3.60	3.05	2.65	2.40	2.15	2.00
Internal	Serviceability	5.16	4.73	4.30	3.87	3.44	3.00	2.55	2.11		
	Strength *	6.50	5.85	5.25	4.70	4.20	3.80	3.45	3.15		

* a capacity reduction factor of $\phi=0.90$ has been applied to strength capacities. Above table is based on support of 1mm BMT.

Limit states wind pressures

KL-700HS offers the full benefits of the latest methods for modelling wind pressures. The Wind pressure capacity table is determined by full scale tests conducted at BlueScope Lysaght’s NATA-registered testing laboratory, using the direct pressure-testing rig.

Testing was conducted in accordance with AS 1562.1—1992 Design and Installation of Sheet Roof and Wall Cladding—Metal, and AS 4040.2—1992 Resistance to Wind Pressure for Non-cyclonic Regions.

The pressure capacities for serviceability are based on a deflection limit of (span/120) + (maximum fastener pitch/30).

The pressure capacities for strength have been determined by testing the cladding to failure (ultimate capacity). These pressures are applicable when the cladding is fixed to a minimum of 1.0mm, G550 steel.

For material less than 1.0 mm thick, seek advice from our information line.

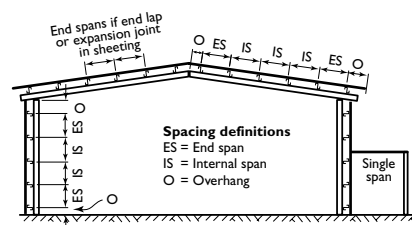

Walking on roofs

Keep your weight evenly distributed over the soles of both feet to avoid concentrating your weight on either heels or toes. Always wear smooth soft-soled shoes; avoid ribbed soles that pick up and hold small stones, swarf and other objects.

Be careful when moving between supports. Do not walk in the pan immediately adjacent to flashings or translucent sheeting. Walk at least one pan away.

Minimum roof pitch

Our unique anti-capillary side lap allows you to use KL 700HS on roof pitches from as low as 1 degree (1 in 50) for 0.48 and 0.60 BMT, and 2 degrees for 0.42 BMT. It can also be used on walls.

Maximum support spacings

Maximum roof lengths for drainage measured from ridge to gutter (m)

Penetrations will alter the flow of water on a roof. For assistance in design of roofs with penetrations, please seek advice from our information line.

Maximum roof lengths for drainage: measured from ridge to gutter (m)

Peak rainfall intensity mm/hr	Roof slope					
	1°	2°	3°	5°	7.5°	10°
100	344	428	502	624	745	856
150	229	285	334	416	496	571
200	172	214	251	312	372	428
250	137	171	201	250	298	342
300	115	143	167	208	248	285
400	86	107	125	156	186	214
500	69	86	100	125	149	171

Adverse conditions

If this product is to be used in marine, severe industrial, or unusually corrosive environments, ask for advice from our information line.

Metal & timber compatibility

Lead, copper, free carbon, bare steel and green or some other chemically-treated timbers are not compatible with this product. Don't allow any contact of the product with those materials, nor discharge of rainwater from them onto the product. Supporting members should be coated to avoid problems with underside condensation. If there are doubts about the compatibility of other products being used, ask for advice from our information line.

Maintenance

Optimum product life will be achieved if all external walls are washed regularly. Areas not cleaned by natural rainfall (such as the tops of walls sheltered by eaves) should be washed down every six months.

Storage and handling

Keep the product dry and clear of the ground. If stacked or bundled product becomes wet, separate it, wipe it with a clean cloth to dry thoroughly.

Handle materials carefully to avoid damage: don't drag materials over rough surfaces or each other; don't drag tools over material; protect from swarf.

Turn up-down tools

On all roofs of pitches less than 15 degrees, the high end of all sheets must be turned up to stop water from being driven under the flashing and into the building.

Similarly, the pans at the gutter end must be turned down to stop water running back along the underside of the sheets.

Tools are available for both applications.

Notching tool

A tool is available for on-site notching of transverse flashings and cappings.

Cutting

For cutting thin metal on site, we recommend a circular saw with a metal-cutting blade because it produces fewer damaging hot metal particles and leaves less resultant burr than does a carborundum disc.

Cut materials over the ground and not over other materials.

Sweep all metallic swarf and other debris from roof areas and gutters at the end of each day and at the completion of the installation. Failure to do so can lead to surface staining when the metal particles rust.

End Laps/Expansion Joints

KL-700HS cannot be end lapped.

Please contact your nearest BlueScope Lysaght service centre for advice on use of an expansion joints. (Or use long length sheets from a mobile rollformer.)

Extra versatility of mobile rollforming

The 0.60BMT thickness is available only from our mobile rollformer. The mobile rollformer delivers on-site rolling for extra long lengths. In some cases the mobile rollformer has the unique ability to 'roll-to-roof' saving you time and money for transport and craneage.

Fasteners without Insulation

Fixing to steel up to 1.0 mm BMT	Fixing to steel 1.0 to 3.0 mm BMT	Fixing to timber
Self drilling, self tapping screws 15-15 x 25	Self drilling, self tapping screws with hex. head 12-14 x 20*	Self drilling, self tapping, wood screws with hex. head <small>SOFTWOOD: 12-11 x 40 HARDWOOD: 12-11 x 25</small>

Note: Use three screws per clip.

*Longer screws may be easier to install (e.g. 12-14 x 30).

Fasteners

Where insulation is to be installed, you may need to increase the length of the screws given below, depending on the density and thickness of the insulation. When the screw is properly tightened:

- into metal: there should be at least three threads protruding past the support you are fixing to, but the Shankguard® must not reach that support;
- into timber: the screw must penetrate the timber by the same amount that the recommended screw would do if there were no insulation.

Curving

Please contact your nearest BlueScope Lysaght service centre for spring curving advice.

Sealed joints

For sealed joints use screws or rivets and neutral-cure silicone sealant branded as suitable for use with galvanised or ZINCALUME® steel.

Non-cyclonic areas

The information in this brochure is suitable for use only in areas where a tropical cyclone is unlikely to occur as defined in AS 1170.2—2002.

For information on the use of LYSAGHT products in cyclonic conditions, refer to the Cyclonic Area Design Manual which is available on our website: www.lysaght.com.



Installation

Preparation

Before starting work ensure that:

- The supports for your cladding are truly in the same plane;
- The minimum roof slopes conform to our recommendations; and
- The overhangs of sheets from the top and bottom supports don't exceed our recommendations.
- The first and last supports and clips should be at least 75mm from each end of the sheet to keep maximum holding power.

Make any necessary adjustments before you start laying sheets, because they will be difficult to rectify later.

Orient sheets before lifting

Consider which end of the building is best to start from. For maximum weather-tightness, start laying sheets from the end of the building that will be downwind of the worst-anticipated or prevailing weather (Figure 1).

It is much easier and safer to turn sheets on the ground than up on the roof. Before lifting sheets on to the roof, check that they are the correct way up and the overlapping side is towards the edge of the roof from which installation will start.

Place bundles of sheets over or near firm supports, not at mid span of roof members.

Steps for installation

- 1 Lay and fix wire mesh to the supports in accordance with the appropriate building requirements. (Figure 2)
- 2 Position the first clips on each support by placing onto the support nearest the gutter. (Figure 3)
- 3 Fix the first clip on the support so they point in the direction of laying. Ensure the clip is 90 degrees to the edge of the sheet.
- 4 Align the clips with the spacer using a string line (or the first sheet as a straight edge) to align the clips as you fix a clip to each support working towards the high end of the roof.
- 5 Drive hex-head screws through the top of the clip, into the support.
- 6 Work along the edge of the gutter, ensuring it aligns correctly at its ends in relation to the gutter and ridge (or parapet or transverse wall).
- 7 Place the glass wool insulation between the supports.
- 8 Measure the distance from the gutter end of the sheet to the support.

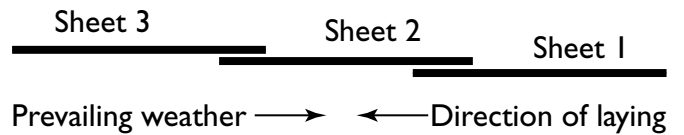
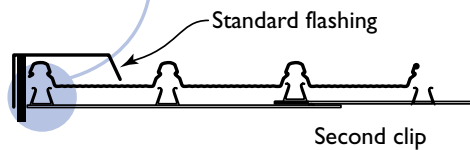
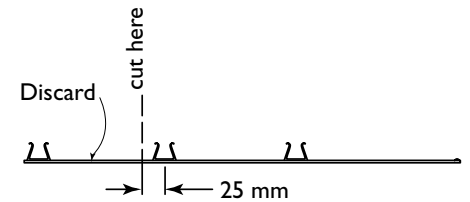
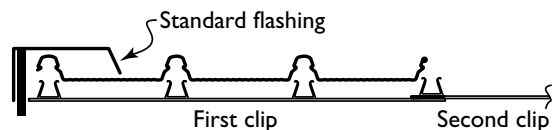

Figure 1
Lay sheets towards prevailing weather



KLIP-LOK 700HS: Starting method 1



KLIP-LOK 700HS: Starting method 2

Figure 2
Alternative methods for first clips

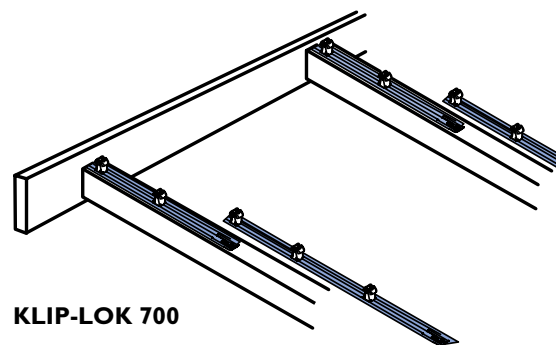

Figure 3
Fix the first row of clips. Fix the next (and subsequent) clips and sheets



- 9 Position the first sheet so that it overhangs the desired amount (usually 50mm) to the gutter. It is important to ensure this first sheet is placed square to adjacent edges. (Figure 4.)
- 10 Engage the sheet with clips using vertical foot pressure on all the ribs over each clip. (Figure 5)
- 11 Fix the next row of clips, one to each support with the slots and tabs engaged. Be sure the clip is 90 degrees to the edge of the sheet.
- 12 As before, place the next sheet over its clips ensuring you also engage the edge of the preceding sheet.
- 13 Accurately position the sheet so that it overhangs the desired amount into the gutter. It is important that you keep the gutter-end of all sheets in a straight line.
- 14 Fully engage the two sheets along the overlapping rib. You can do this by walking along the full length of the sheet with one foot in the centre pan of the previous sheet and the other foot applying vertical pressure to the top of the interlocking ribs at regular intervals. It is important that you don't walk in the unsupported pan beside the overlap. (Figure 5)
- 15 Similarly, engage all the clips by applying vertical foot pressure to the top of the other two ribs over each clip.

It is essential that the sheets interlock completely. It is important that your weight is fully on the sheet you are installing.

Check alignment occasionally

Occasionally check that the sheets are still parallel with the first sheet, by taking two measurements across the width of the fixed sheeting.

At about half way through the job, perform a similar check but take the measurements from the finishing line to aim for the final sheet to be parallel with the end of the roof. If the measurements are not close enough, lay subsequent sheets very slightly out of parallel to gradually correct the error. (Figure 6) To allow this to happen, flatten the tabs on the base of subsequent clips—the slot in the clip will allow the clips to be fixed out of standard pitch.

Fix the last sheet

If the final space is less than the full width of a sheet, you can cut a sheet along its length and shorten the clips as appropriate. It is desirable to fix the sheet at one end.

Installing KLIP-LOK 700 HI-STRENGTH walls

The installation procedure for walls is similar to that described for roofs. To prevent KL-700HS from sliding downward in the fixing clips, you should pierce-fix through each sheet under the flashing or capping, along the top of the sheets.

Installing translucent sheets with KLIP-LOK 700 HI-STRENGTH

Because of its greater thermal expansion, translucent cladding should be fixed using oversized holes and sealing washers recommended by the cladding manufacturer. When used with concealed fixed claddings, ensure the fasteners do not penetrate the steel cladding. There are translucent products available that easily accommodate this.

Note: Don't exceed the maximum support spacing specified by the translucent cladding manufacturer. Use of translucent sheeting may result in lower limit state capacities.

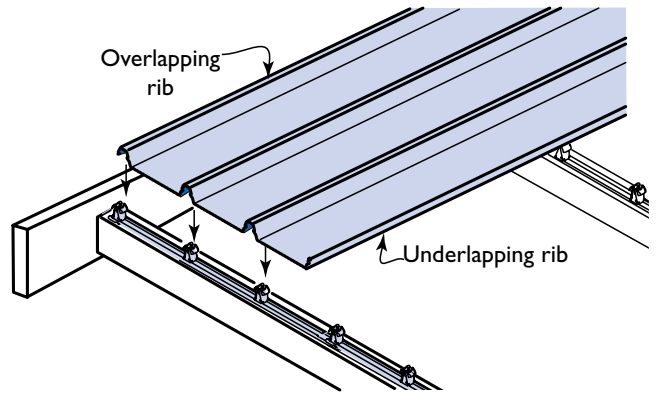

Figure 4
Placing the first sheet

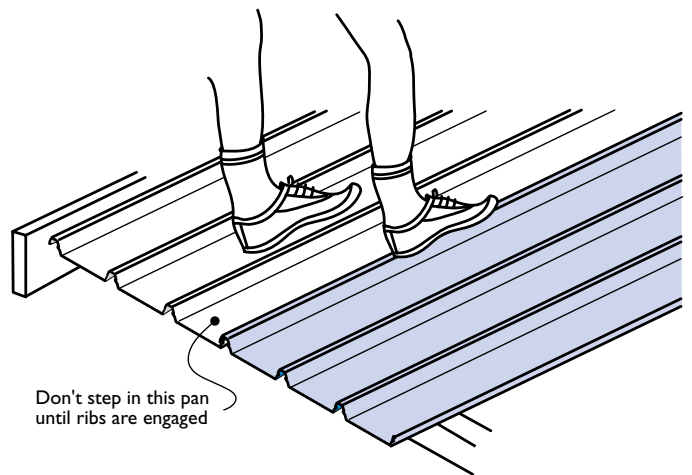

Figure 5
Engaging the lapping ribs

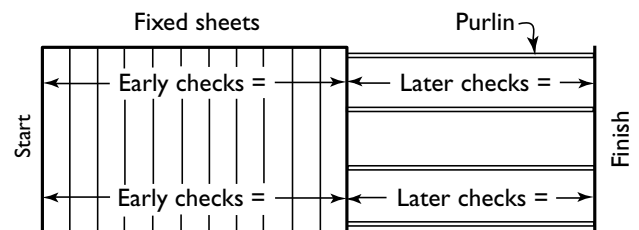

Figure 6
Check alignment occasionally

Rainwater solutions

LYSAGHT® rainwater goods

Whether you're searching for a distinctive look for a new home or looking for an economic solution for a large commercial project BlueScope Lysaght offer an extensive range of rainwater solutions.

Our domestic rainwater goods are manufactured from ZINCALUME® steel with COLORBOND® steel colours available, so they'll stand up to years of the harshest Australian climate.

The choice of colours and styles is extensive, covering everything you could need from gutters and downpipes, to fascia, flashings and cappings, as well as fasteners and fixing clips.

Domestic gutters and downpipes

We manufacture the perfect guttering system for your home, whatever the style. You can choose from Quad, TRIMLINE®, SHEERLINE® or a number of other designs.

All designs can be complemented with our complete range of square and round downpipes and rainwater accessories.

To ensure quick and easy installation there is also a full range of matching fixing clips.

Fascia

The NOVALINE® fascia is attractive and easy to install. It is strong, lightweight and can be used as a complete system. Special clips are also available to fix quad and trimline gutters to the fascia.

Commercial/industrial drainage systems

There is a standard procedure for designing the drainage of a roof using an eaves & gutter system. It is assumed that the gutters will have a gradient steeper than 1:500. Box gutter systems can be more complex and are thoroughly treated in AS/NZS 3500.3:2003.

We manufacture the perfect guttering system for your structure, whichever type is appropriate.

All designs can be complemented with our complete range of square and round downpipes and rainwater accessories. To ensure quick and easy installation there is also a full range of matching fixing clips.

A total solution

BlueScope Lysaght provides a broad range of roofing and rainwater products for industrial building solutions which complement long length KL-700HS. Our guttering systems can be tailor-made for your project.

Why you should always insist on BlueScope Lysaght

When you specify LYSAGHT products you have the added advantage of dealing with a company whose expertise and experience with steel stretches back for well over a century. A company with a reputation for consistently producing top quality products at competitive prices.

Our products are backed by a performance warranty for up to 25 years. When a BlueScope Lysaght warranty is granted, it guarantees in writing that your products will perform exactly to specifications when installed and maintained in accordance with our recommendations.

Terms and conditions apply - see www.lysaght.com.

Domestic rainwater solutions

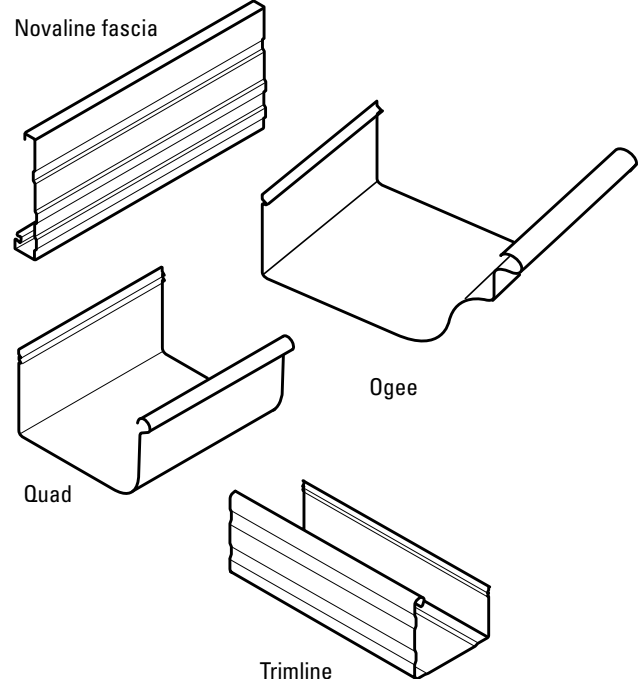

Commercial rainwater solutions

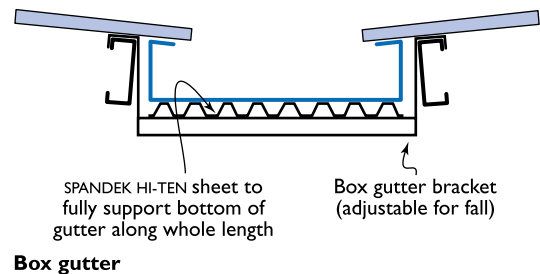

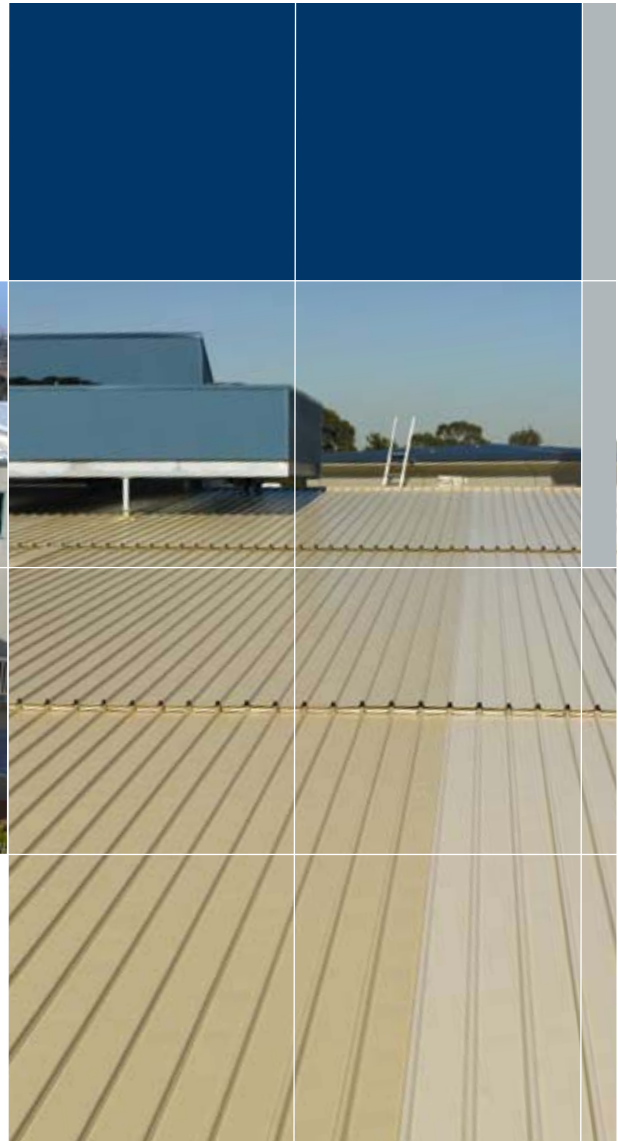

COLORBOND® steel with new THERMATECH® technology

The next generation COLORBOND® steel incorporates THERMATECH® technology, which provides a new level of thermal protection by absorbing less heat. Average reduction in solar absorption across all colours is 5%.

Now 14 of the 20 COLORBOND® steel colours are 'medium to light' under the BASIX colour classification, which means reflective foil at the roof is not required. It also means a drop of R0.5 for roof insulation.

Disclaimer, warranties and limitation of liability

This publication is intended to be an aid for all trades and professionals involved with specifying and installing LYSAGHT products and not to be a substitute for professional judgement.

Terms and conditions of sale available at local BlueScope Lysaght sales offices.

Except to the extent to which liability may not lawfully be excluded or limited, BlueScope Steel Limited will not be under or incur any liability to you for any direct or indirect loss or damage (including, without limitation, consequential loss or damage such as loss of profit or anticipated profit, loss of use, damage to goodwill and loss due to delay) however caused (including, without limitation, breach of contract, negligence and/or breach of statute), which you may suffer or incur in connection with this publication.

© Copyright BlueScope Steel Limited September 14, 2009



Please check the latest information which is always available at:

www.lysaght.com

Technical enquires: steeldirect@bluescopesteel.com or call 1800 641417

LYSAGHT, KLIP-LOK 700 HI-STRENGTH, NOVALINE, TRIMLINE, THERMATECH, SHEERLINE, COLORBOND and ZINCALUME are registered trademarks of BlueScope Steel Limited, ABN 16 000 011 058. Shankguard® is a registered trademark of ITW Buildex. The LYSAGHT® range of products is made by or for BlueScope Steel Limited trading as BlueScope Lysaght. Printed by BMP2M0909



9 320075 060114